

POCKETS OF HOME

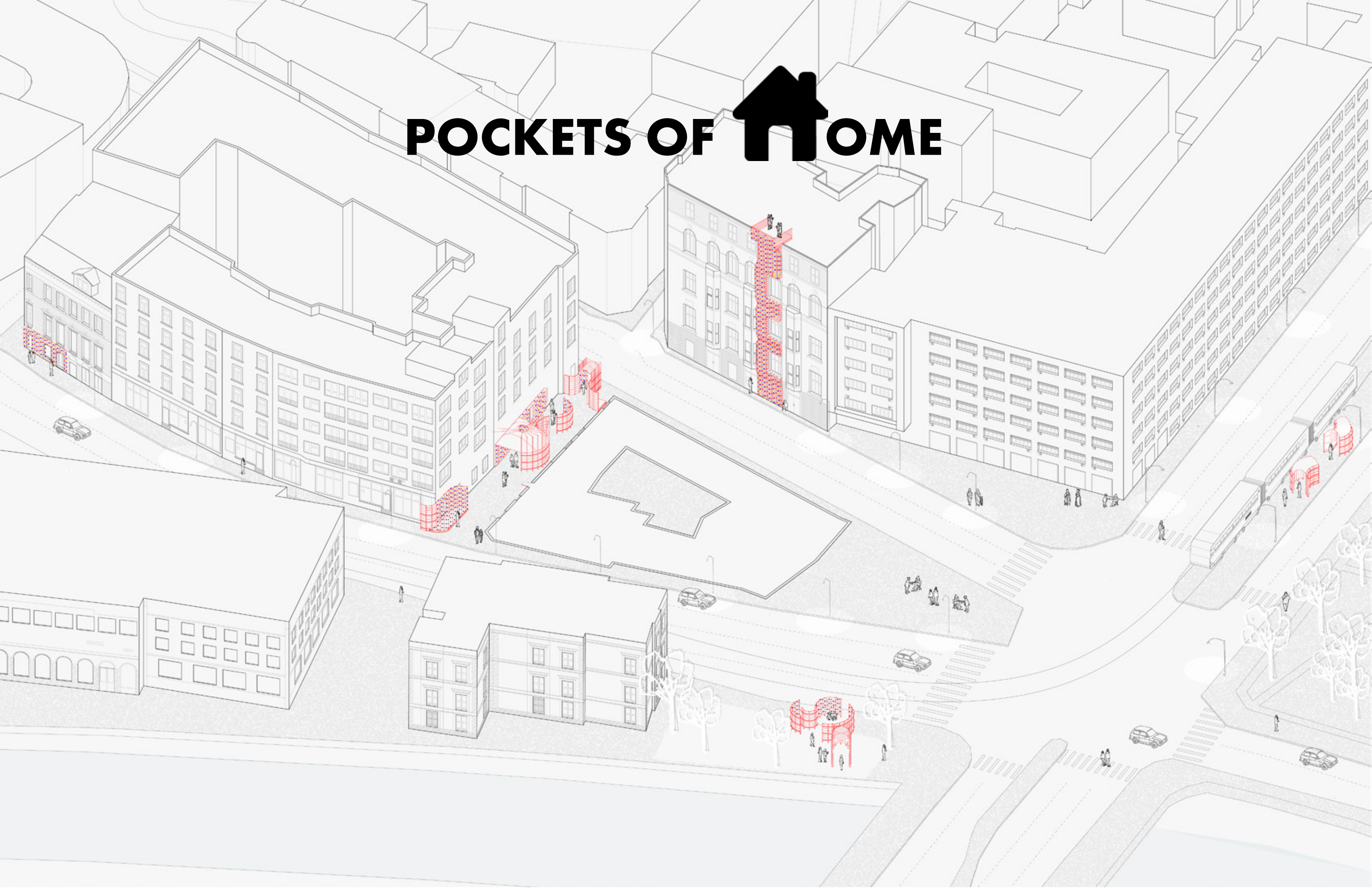

Oftentimes, the experience and feeling of **“home”** can be overlooked in places where a “home” is a privilege and a fortune (typically places that are economically, politically and socially prosperous). However, for those who have experienced the loss of a home, either by choice or by force, there is a heavier significance and meaning given to the word.

Where a house is the typical physical confines of where the comfort of a “home” lies, a home is not strictly linked to a house in every person’s opinion.

In a country like former Yugoslavia, the dissolution caused after the war in the 90’s led to disorientation and ethnic rifts amongst the different ethnic communities (Bosnians, Serbians, and Croatians). People fled their homes to find refuge in unfamiliar and uncomfortable environments. There was a constant push and pull of land ownership and an intangible boundary between these groups that hindered progress and debate after the Bosnian War. However, as a developing country, it is important to encourage **dialogue** between these different ethnic groups not only to promote peace, but to ultimately **engage in exchange** and collectively resolve problems that arise from thought.

Therefore, the urban interventions that are being introduced in this project aim to provoke thought and bring about nostalgia that the community can reflect on as the feeling of “home”. This nostalgia should **induce moments of pause** in the daily routine of a normal civilian and create spaces of **gathering and reflection** amongst these varying cultural and ethnic people. Allowing for an escape away from home and work - similar to coffee shops - these interventions will offer a home away from home in the interstitial spaces of a typical civilian’s commute.

RESEARCH



war and destruction leads to displacement

The dissolution of Yugoslavia in the 90's led to much of the population experiencing displacement, as war destroyed communities and homes.

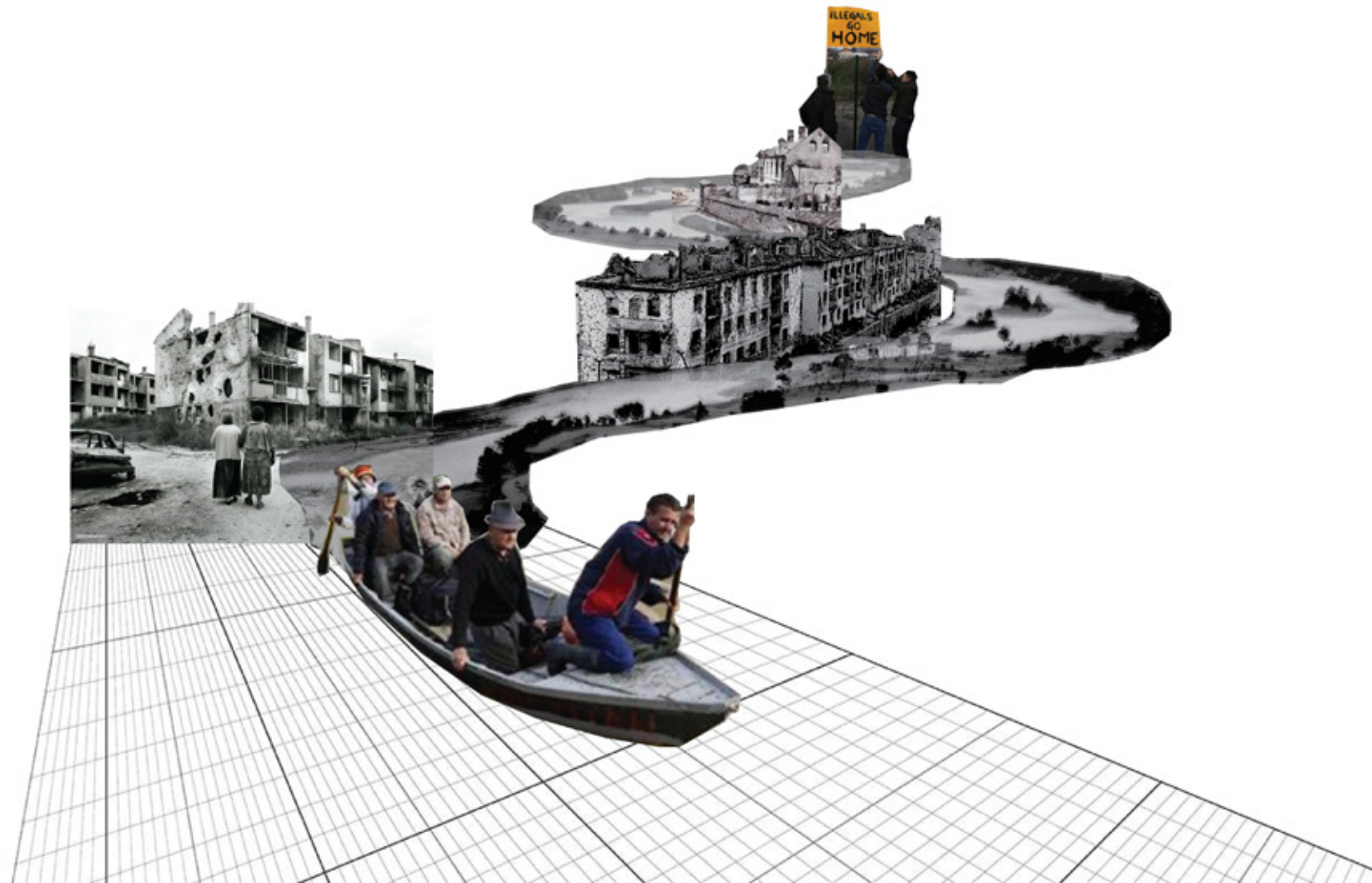

water as a vector | navigation away from violence

Water can be seen as a representational vector away from the violence of war, and as a destination. Now the region of Bosnia Herzegovina is mostly landlocked and opportunities are sought in places with strong associations with industry, opportunity, and water.

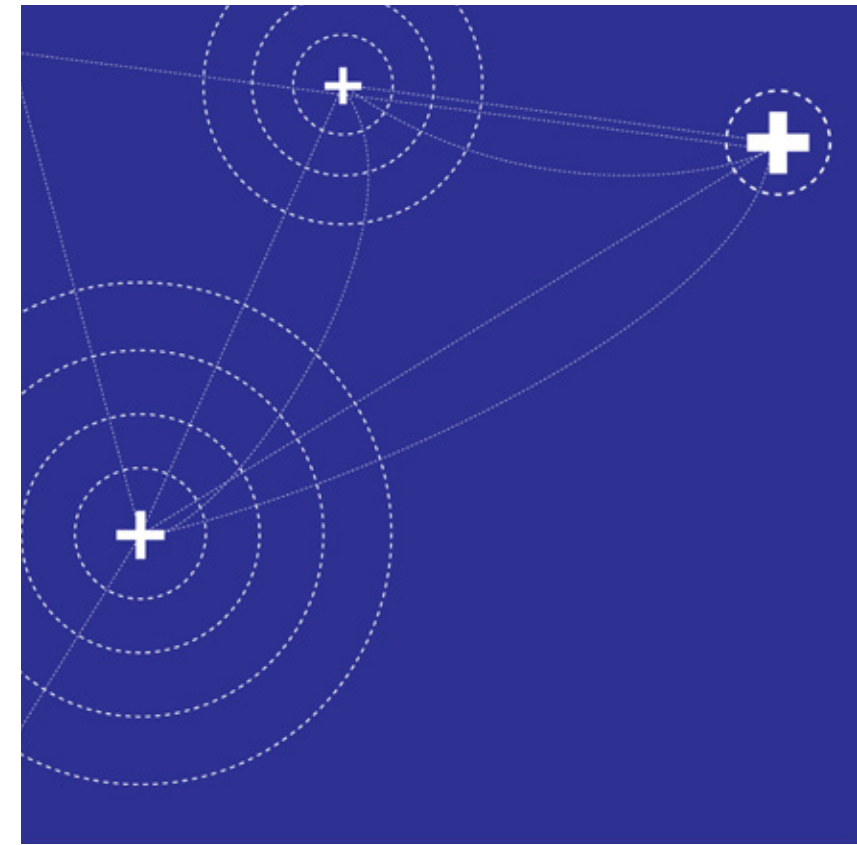
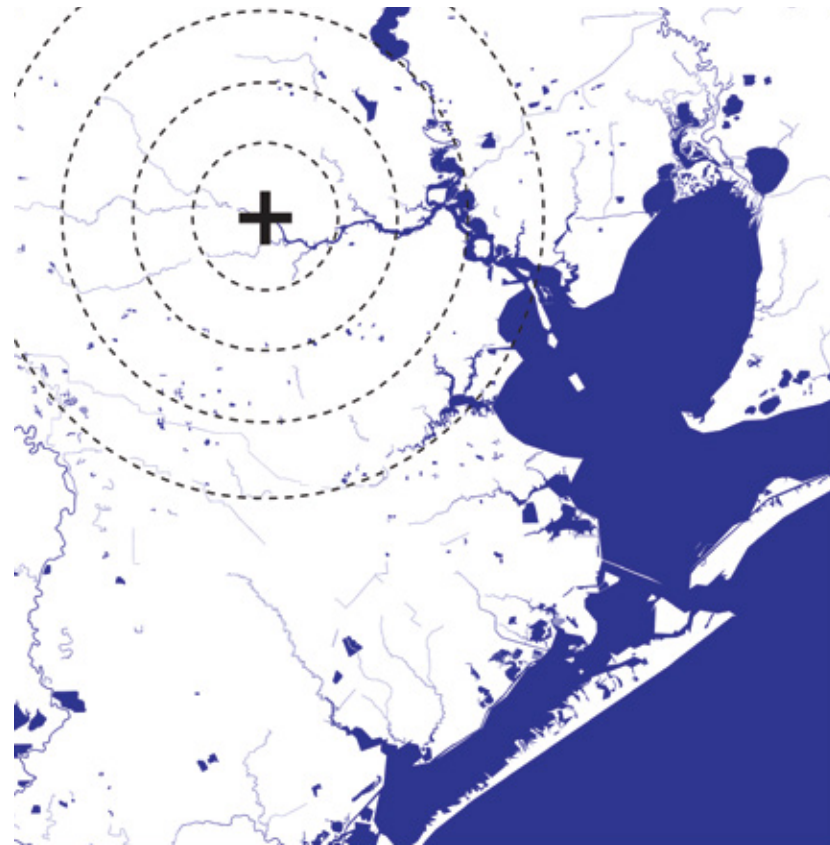

multiple ports of home | where is the feeling of home? | constant disorientation

The relationship with these new homes becomes even more complex over time, as people begin to move from the original homes of refuge, across countries and continents. **As they return to the former Yugoslav states, how has their identity with the place shifted? Do they still identify with the former state, do they identify with one of the current nations? Are they accepted by those who stayed behind?** Many questions of identity arise and with them the question of what is home is ever present.

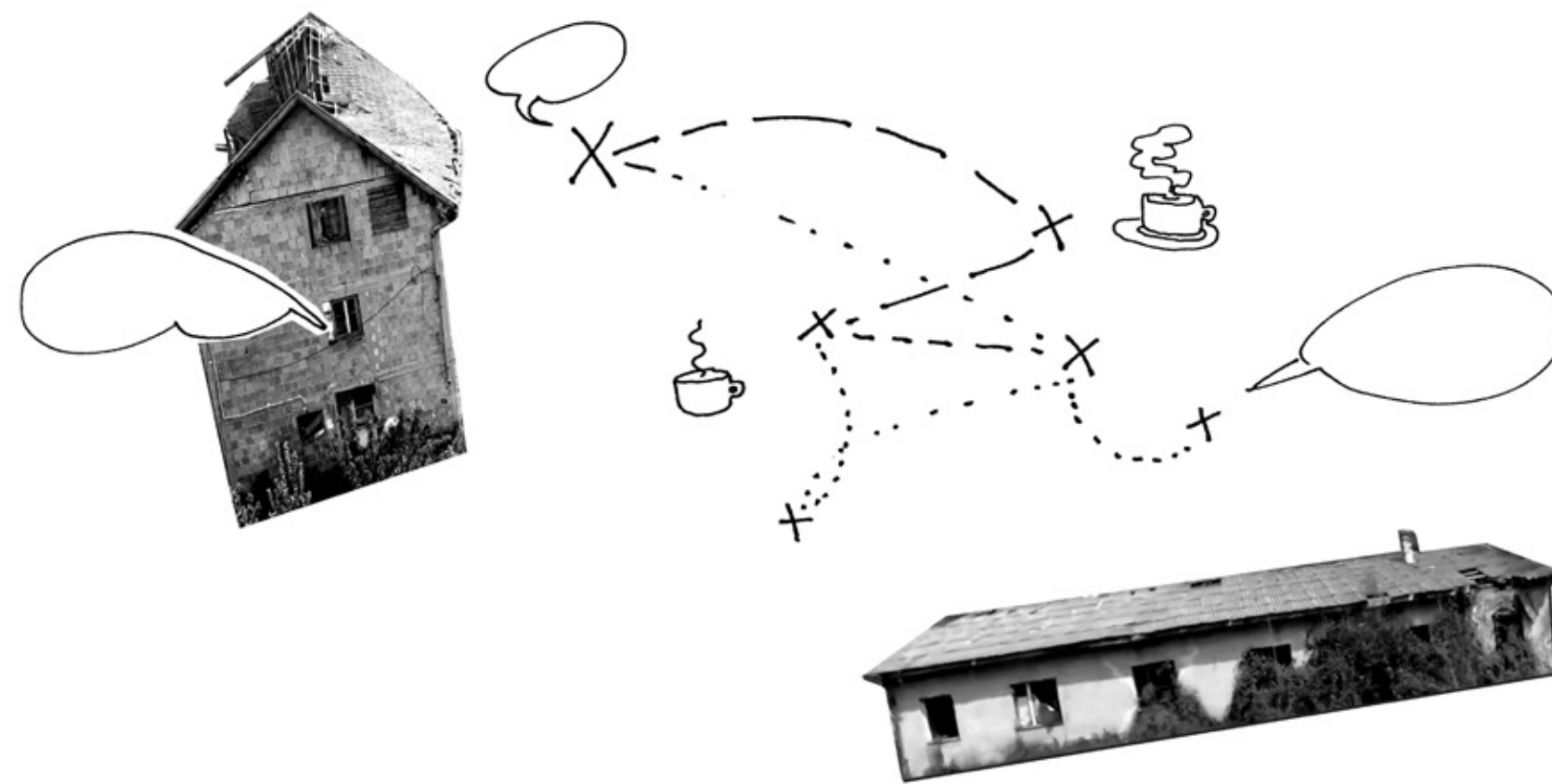

home | coffee | dialogue

From the exploration of home comes the **thread of dialogue** on familiarity, hominess, the spirit of home that follows you beyond the four walls of a house. There exist the spaces of home that are available to everyone - the places you go to retreat to become **familiar habits** and **familiar conversations**. This is where we begin to look at the role of coffee shops as a second home.

PROGRAM + CONCEPT

What activities prompt the feeling of home?

leisurely activities?

how to prompt dialogue through leisure...

relaxation + be at home can be in the middle of the path of resilience / intercepting people in their path.

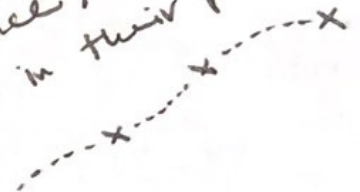

intervention and infill in daily life

bridging cultures together

offering crazy interventions

"moments of pause..." throughout everyday life

How can we spike dialogue? crazy background + history...

SEDATE the masses!

how? through program

transition b/w work and home only feel "home" when you leave home

culturally vibrant moments

What are common programs of people's daily lives?

public transportation?

common homelike materials fabric + wood loving about warmth

- coffee
- lukkah
- meditation
- praying
- dancing
- sleeping
- resting

fun + function given in the operations of a typical home

physical + metaphorical tension

common activities in Bosnia - needlework, heklanje, egg decorating, smoking

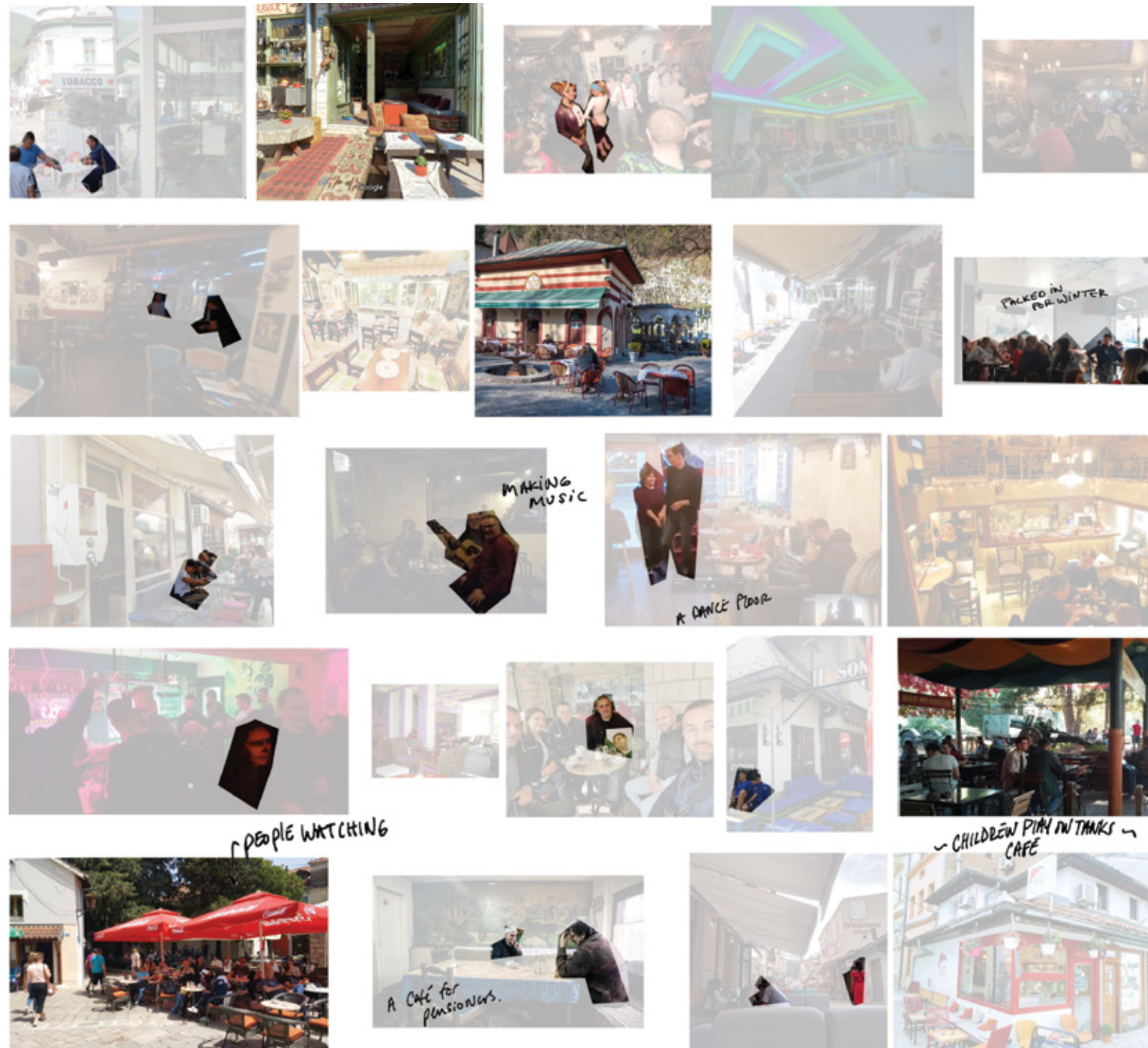

conditions of coffee shops around Sarajevo

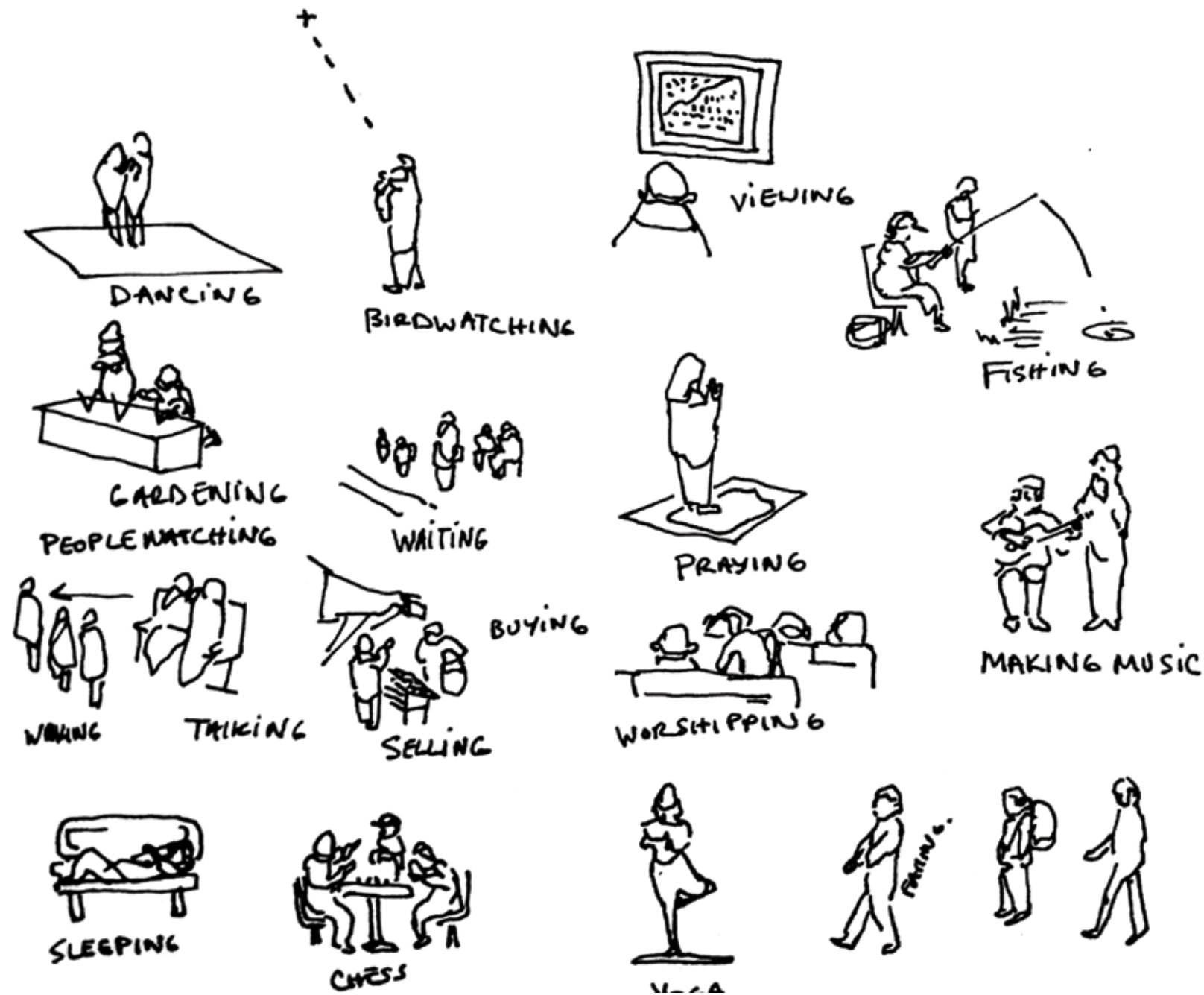

moments of pause | sedation methods | potential activities



movement of daily life



interventions of home (sedation) in the path of daily life

DESIGN

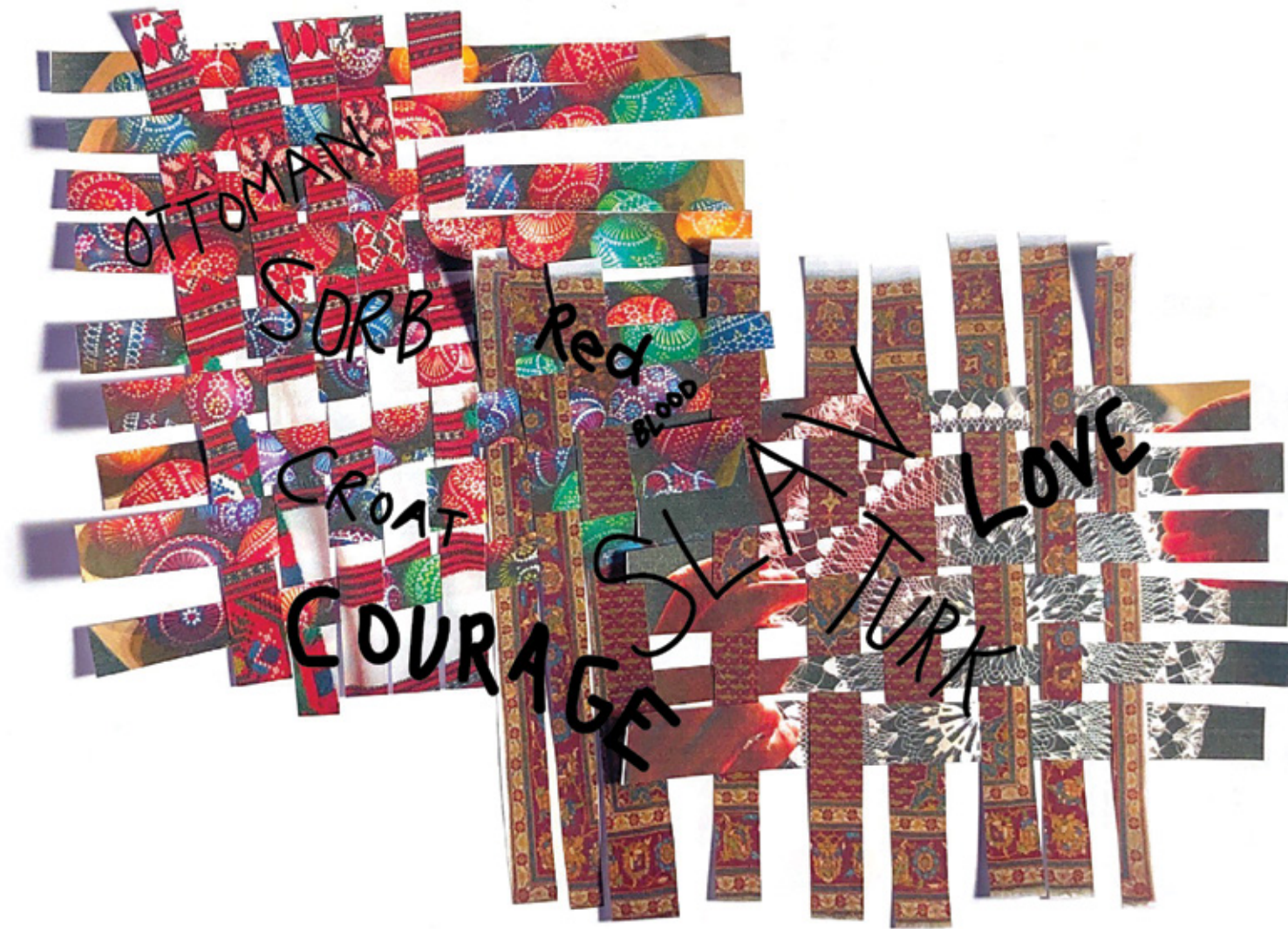

contrasting elements | cultural elements of intervention

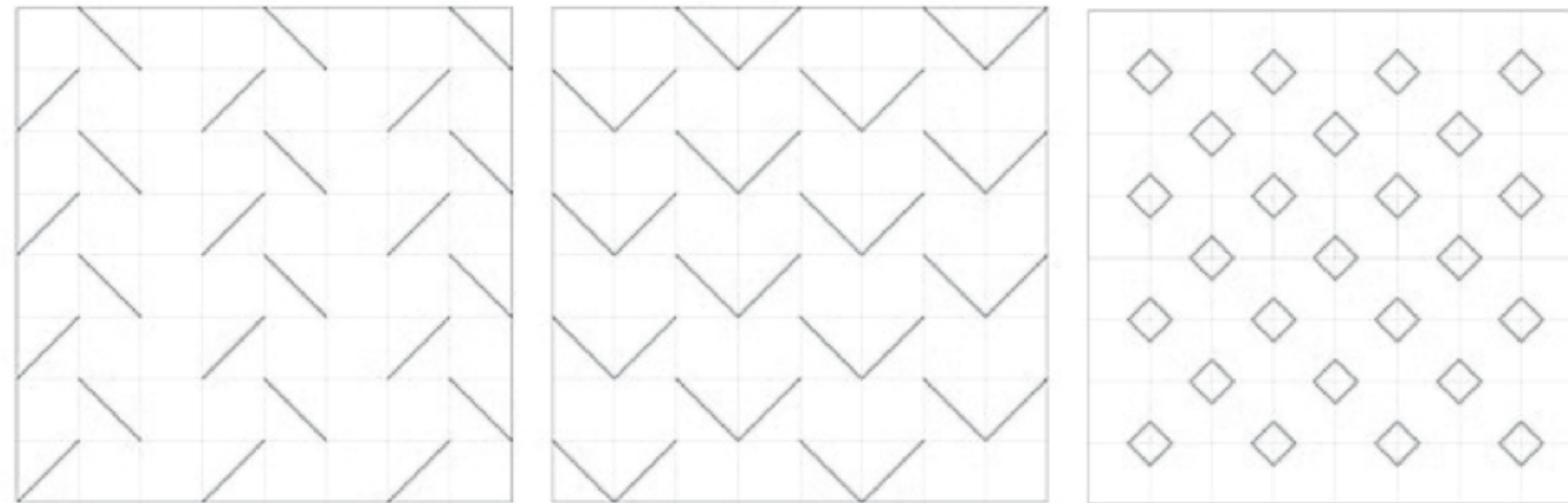
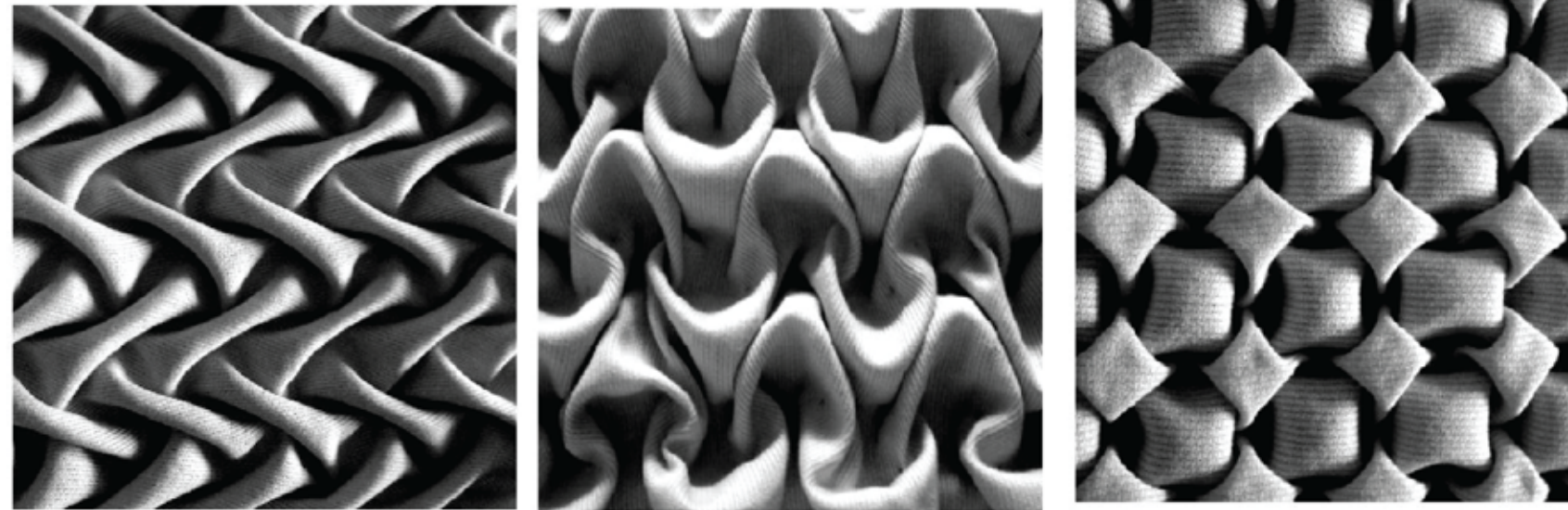

Smocking is a hand stitching technique that creates a voluminous, folded design on the front of a fabric. This technique is usually done with a stitching grid to indicate specific pinch points and fold points.

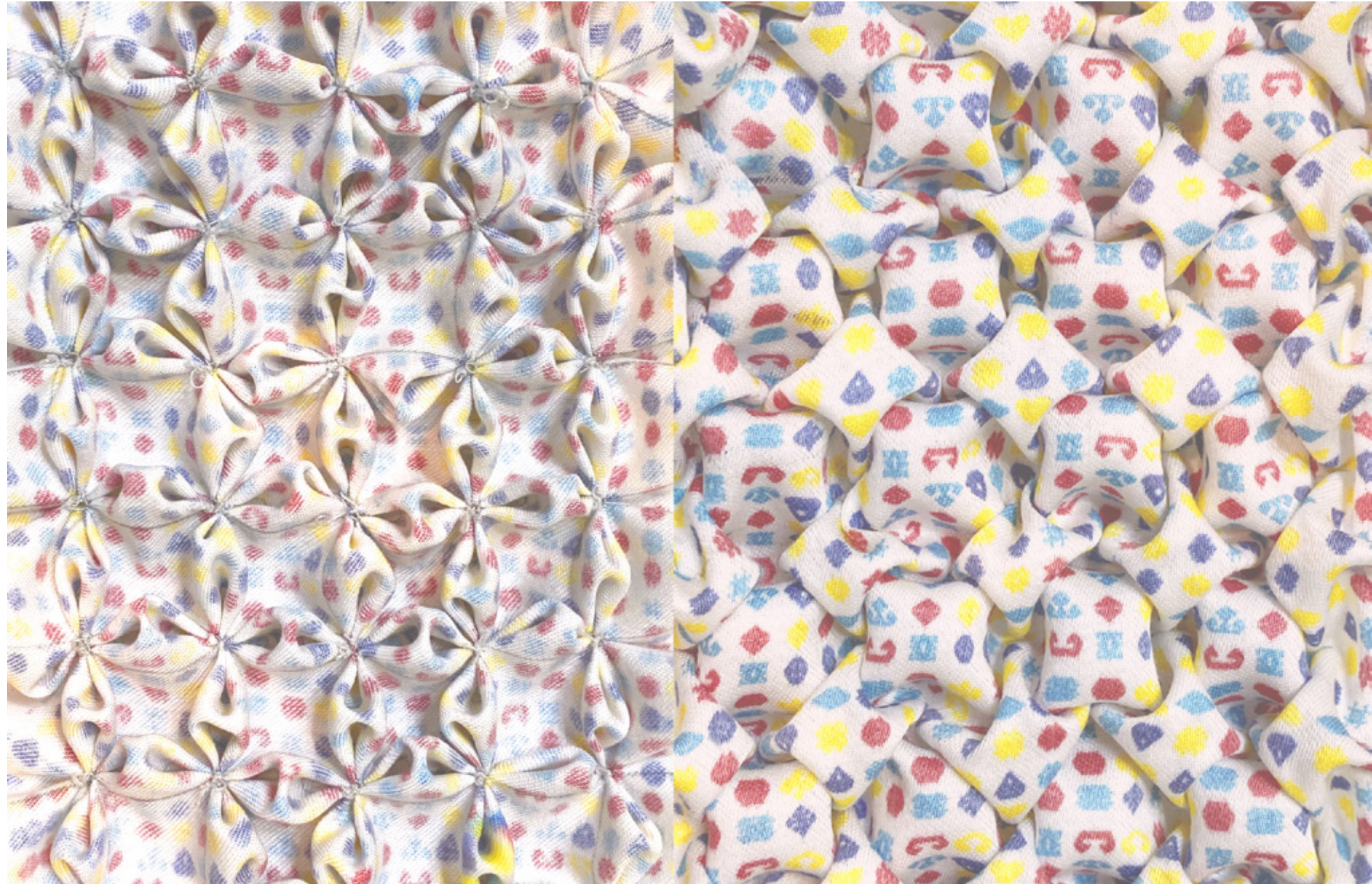

pattern and smocking



Gathering of cultural motifs and symbols

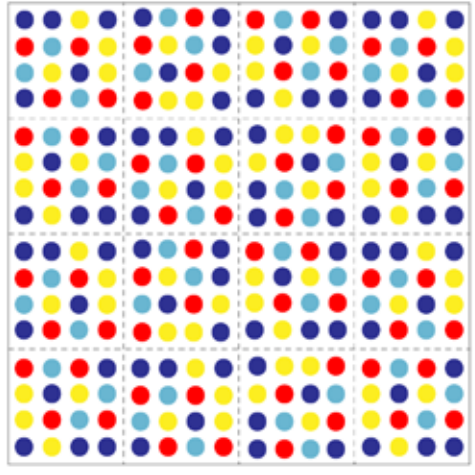

Organizing and joining the quilt squares

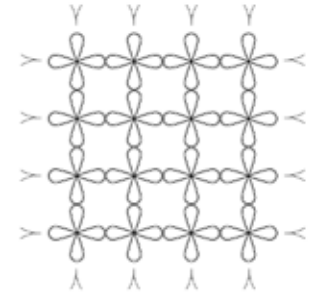
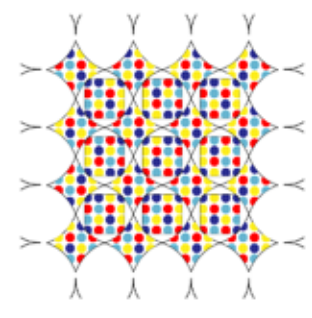
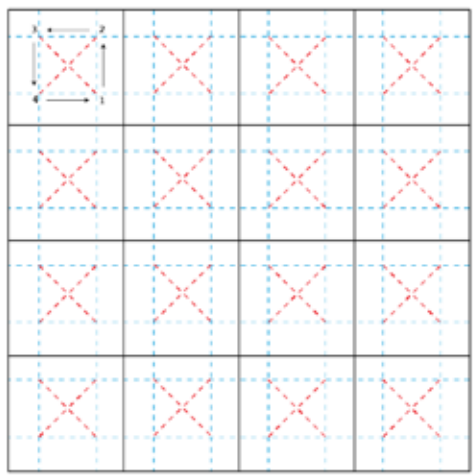

Smocking

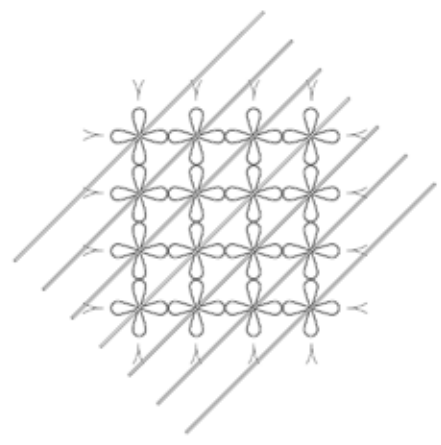
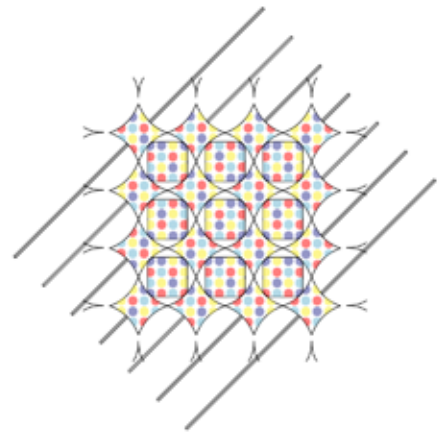

Structure Implication 1

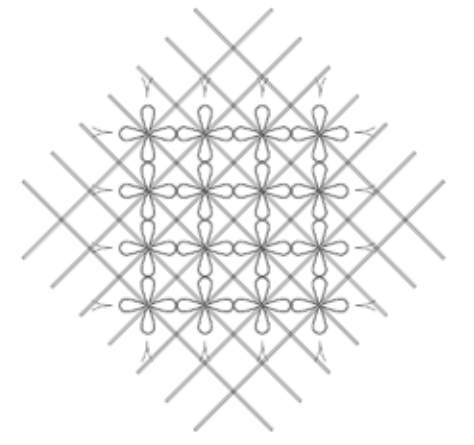
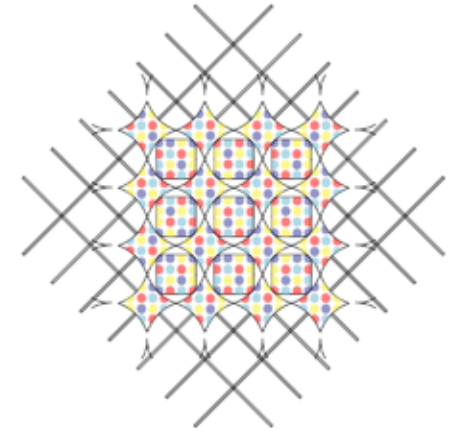

Structure Implication 2



+



+



Material + Technique + Pattern Culture

Smocking Front

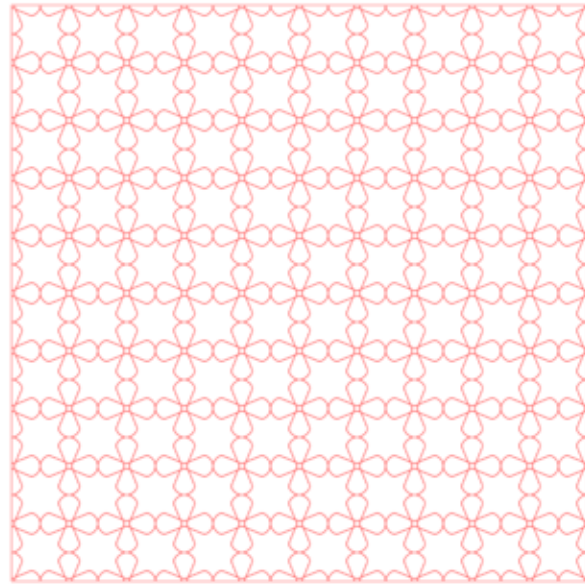

①

Smocking Back | Wire

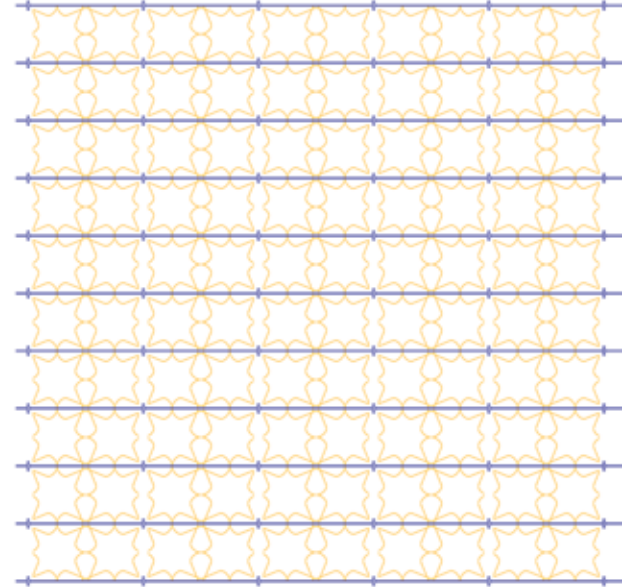

②

Smocking Back | Wire + Wood

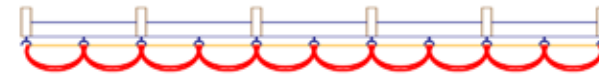
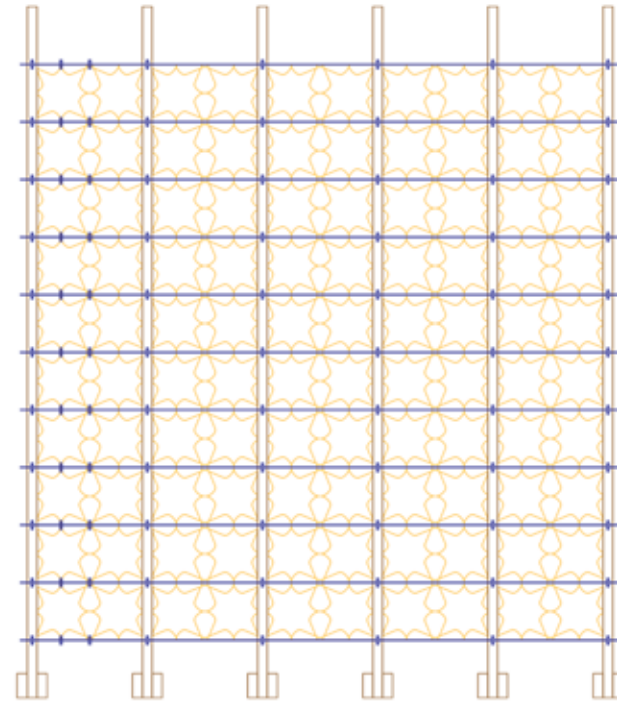

③

Smocking Back | Wire + Wood Scaffolding

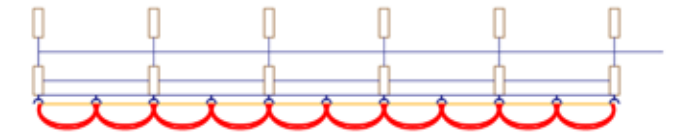
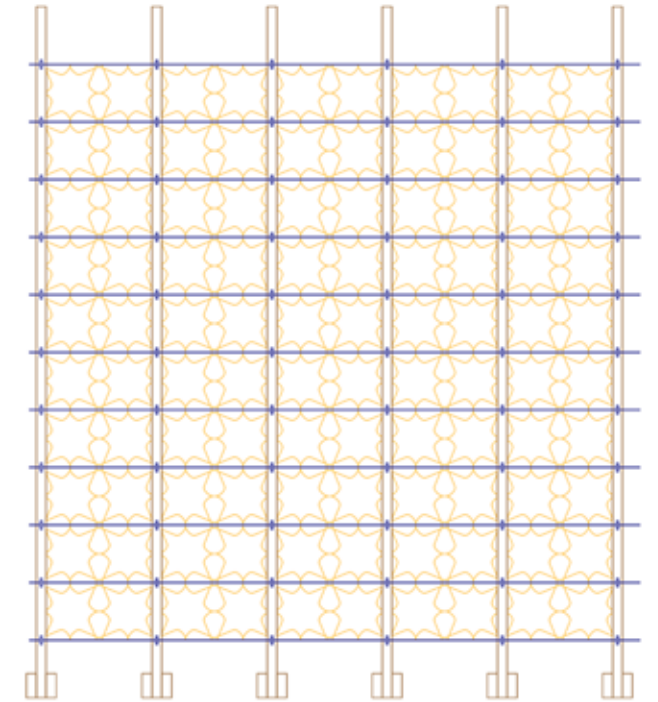

④

Smocking Structure Options

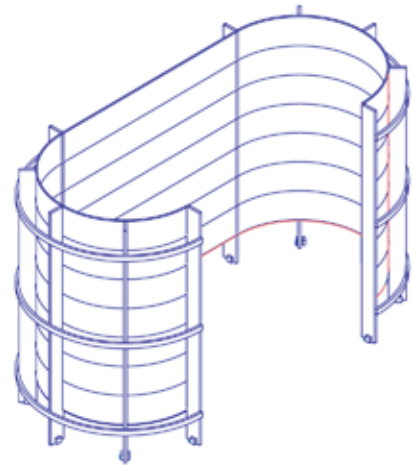

1

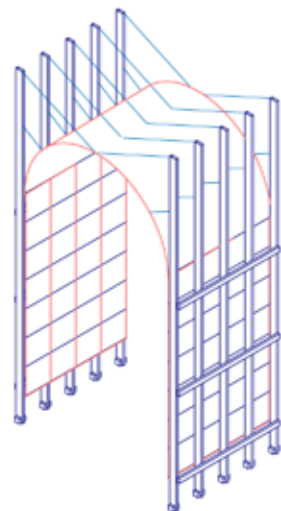

2

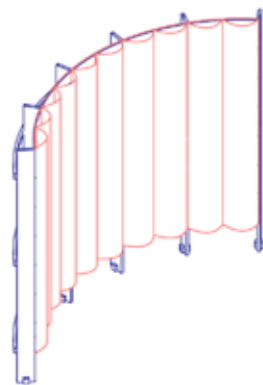

3

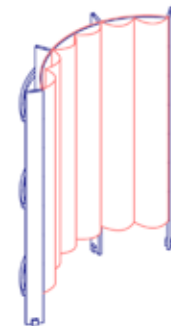

4

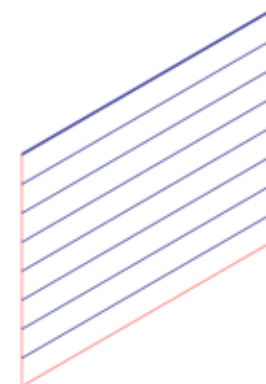

5

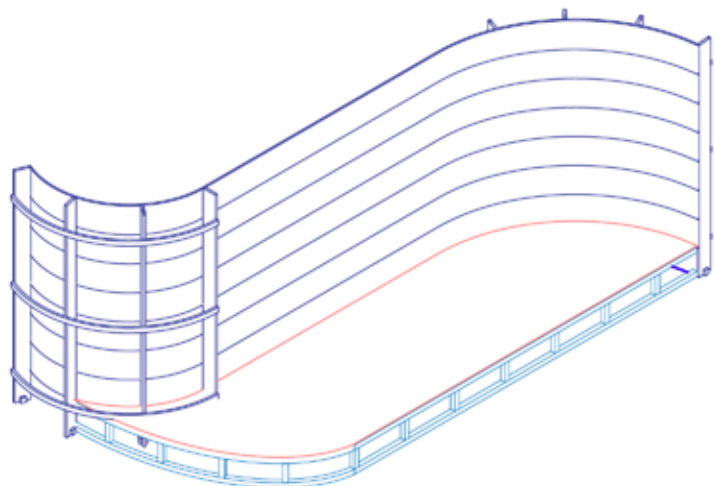

6

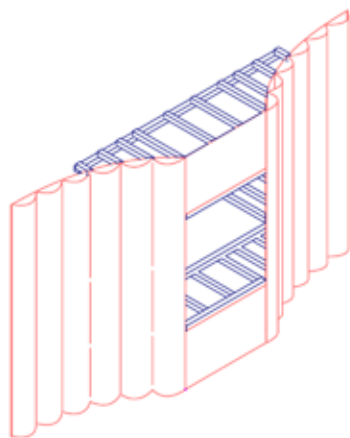

7

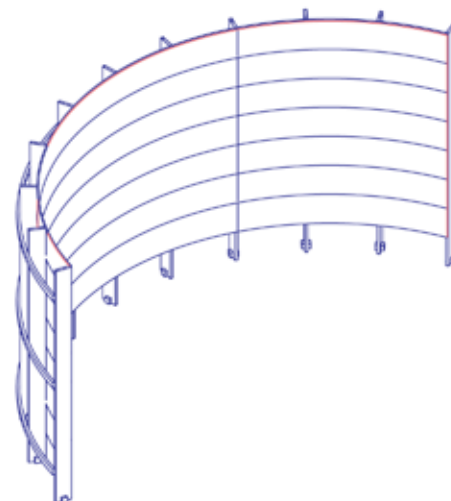

8

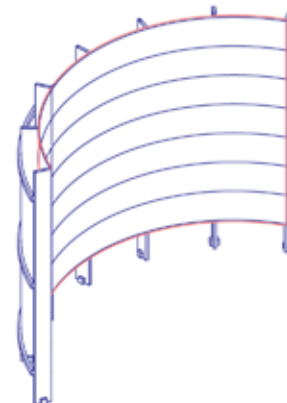

9

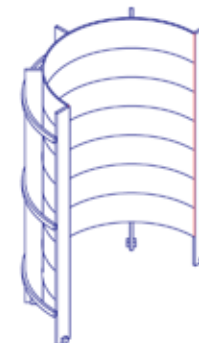

10

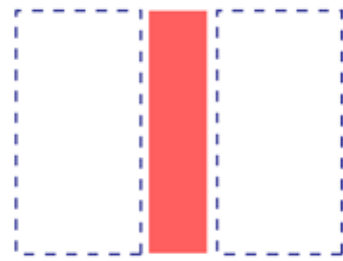

Alley Infill



Sidewalk



Skin/Facade

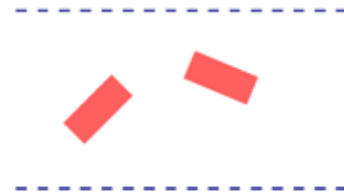

Open Field/Plaza



Bus Stop

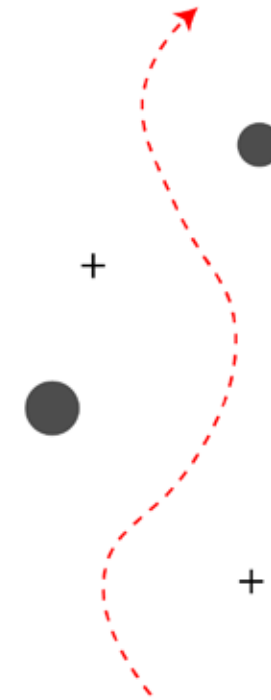

Intervention Types - Diagrams

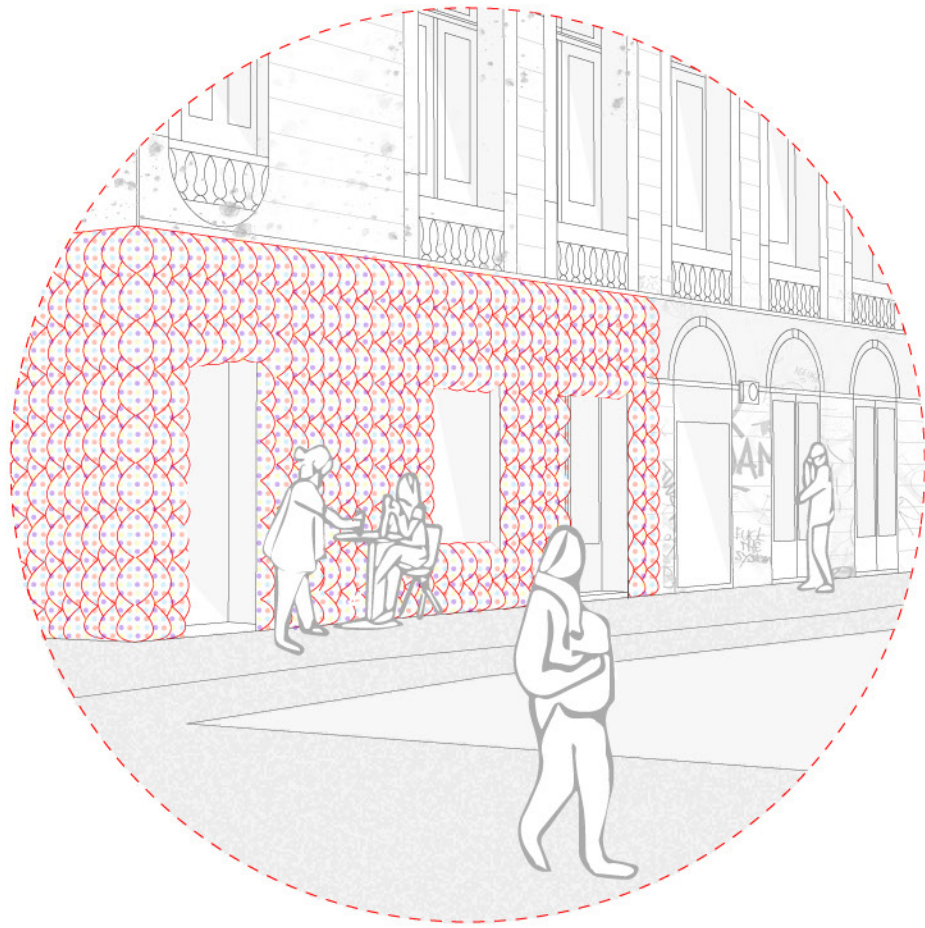

Sidewalk Condition

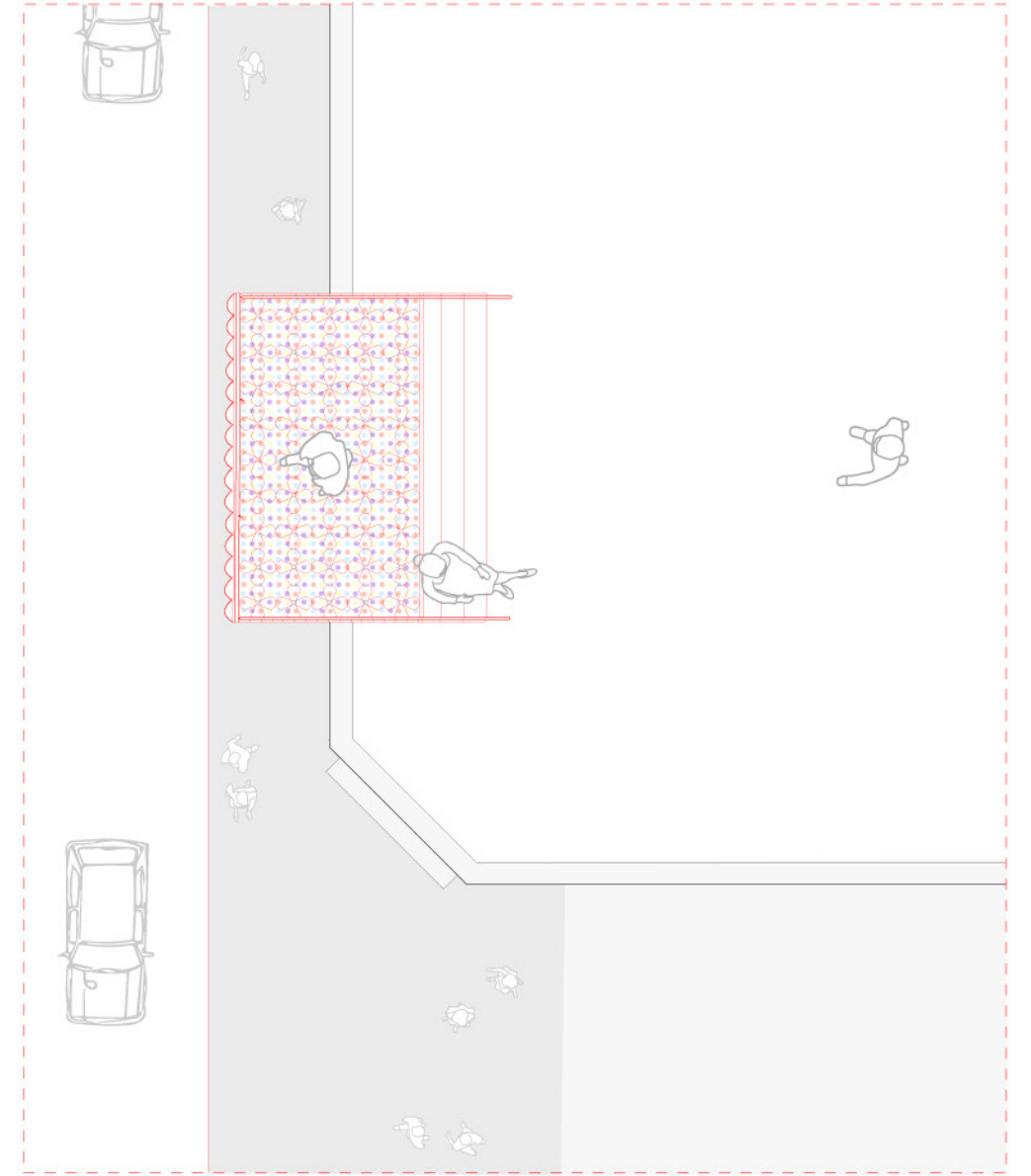
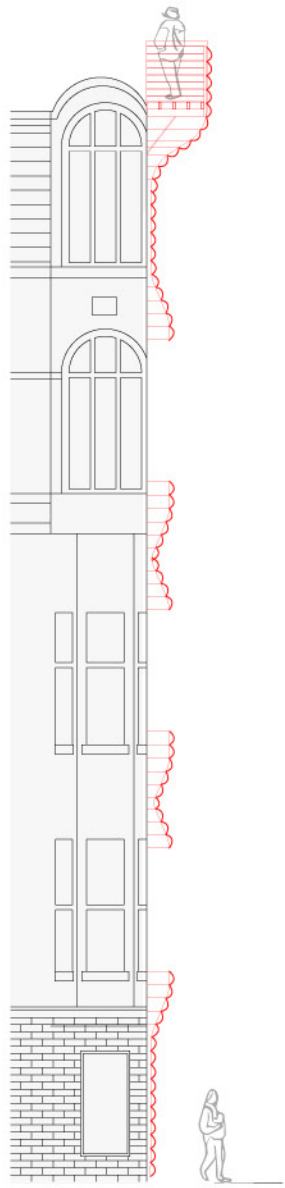

Facade Condition

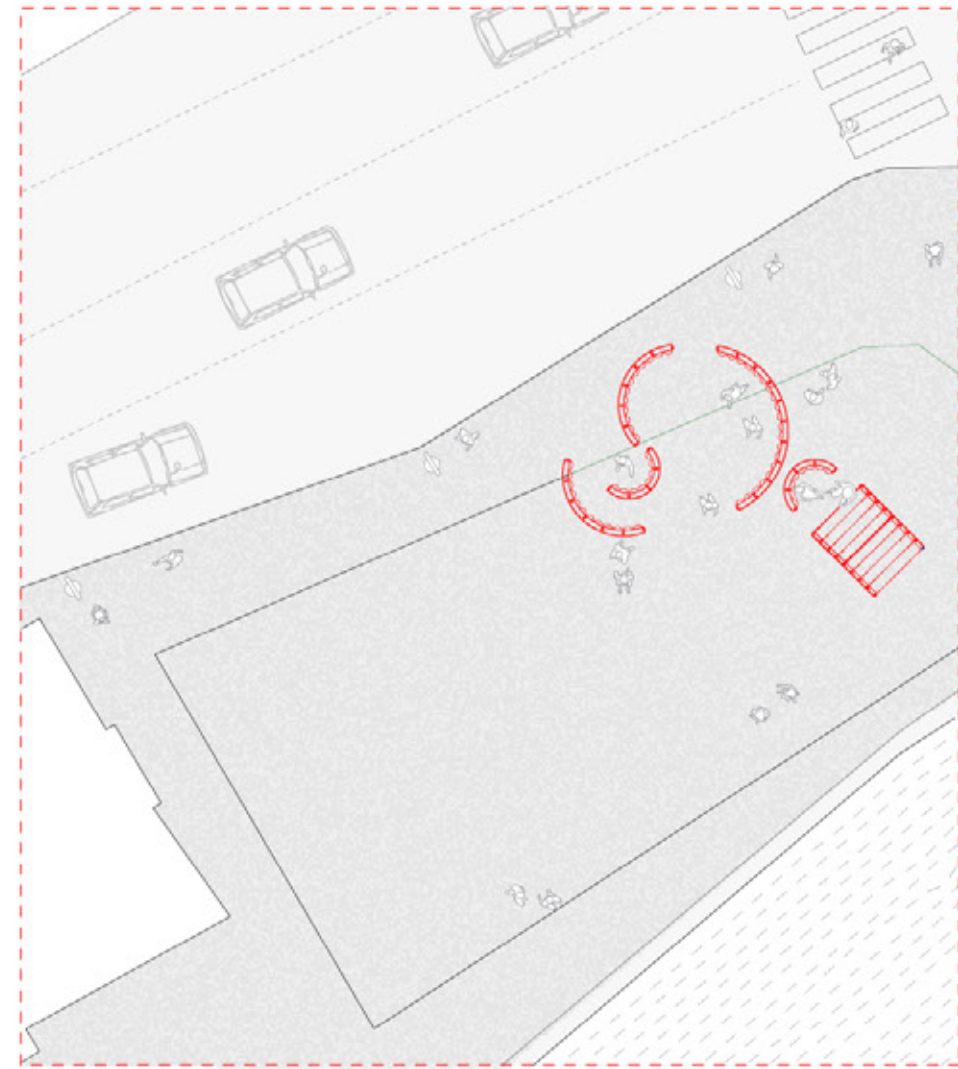
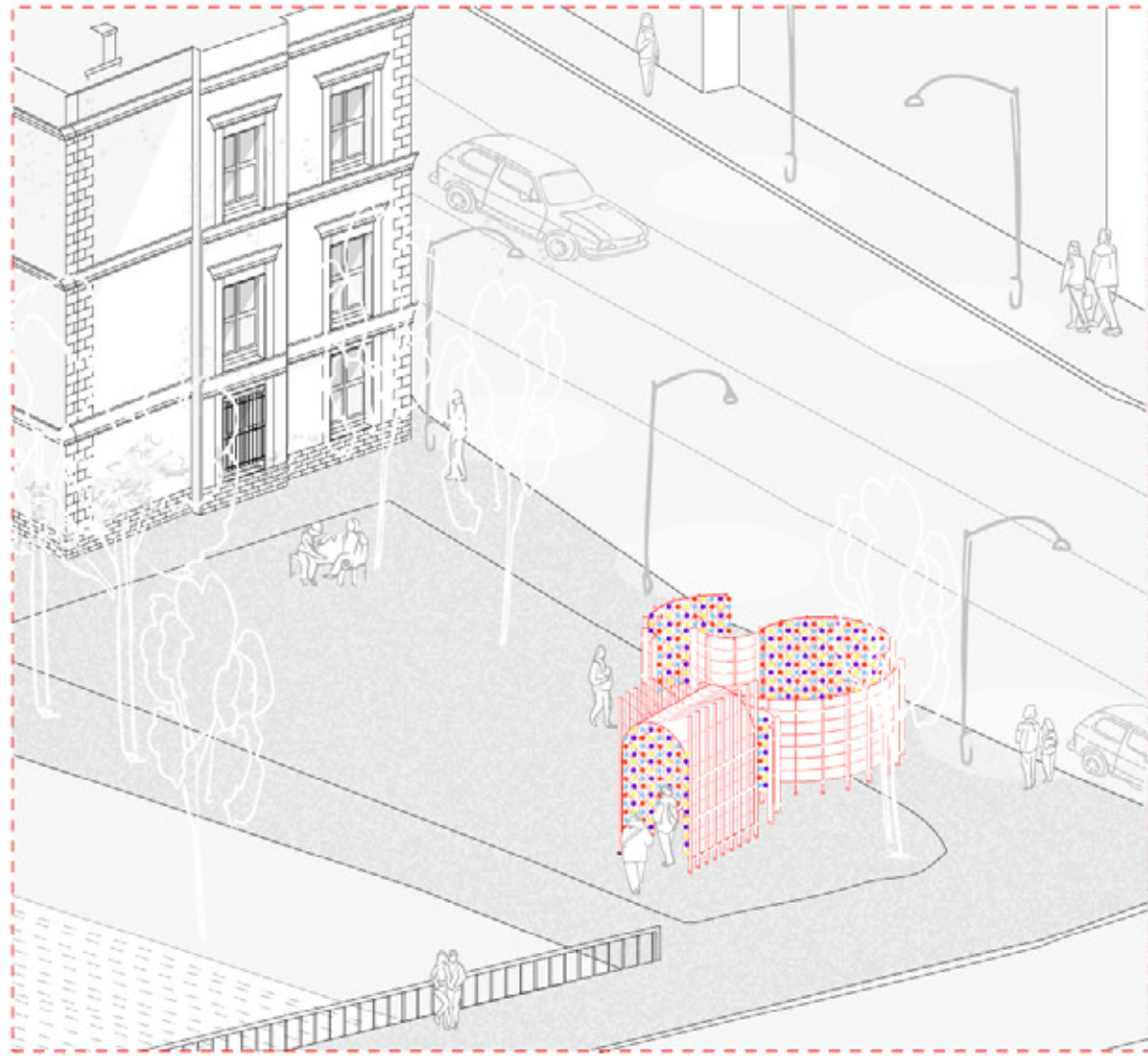

Freestanding Condition

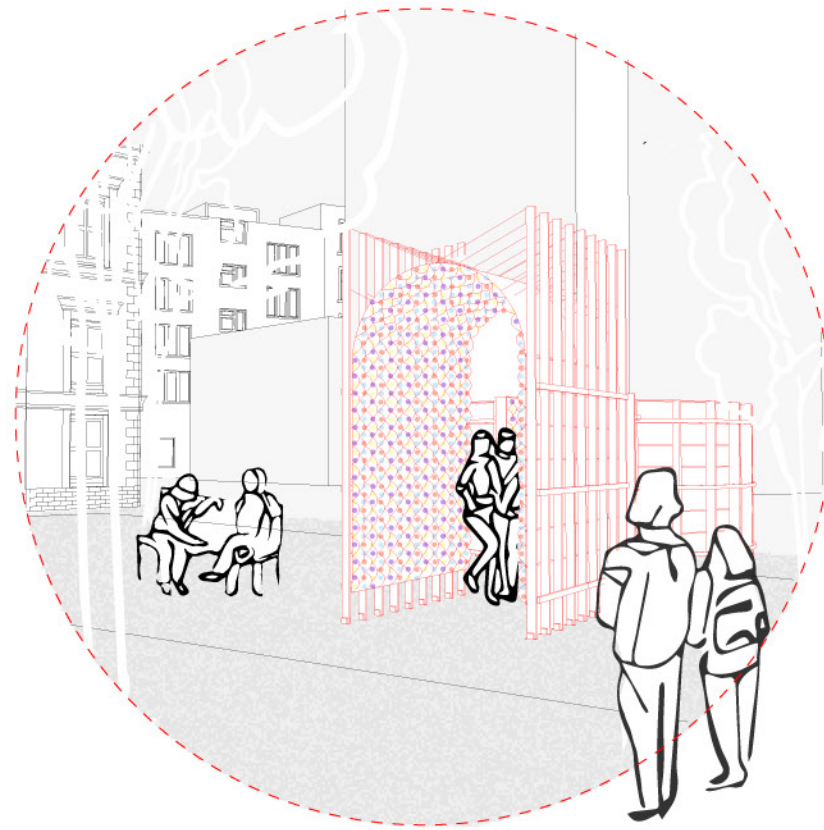
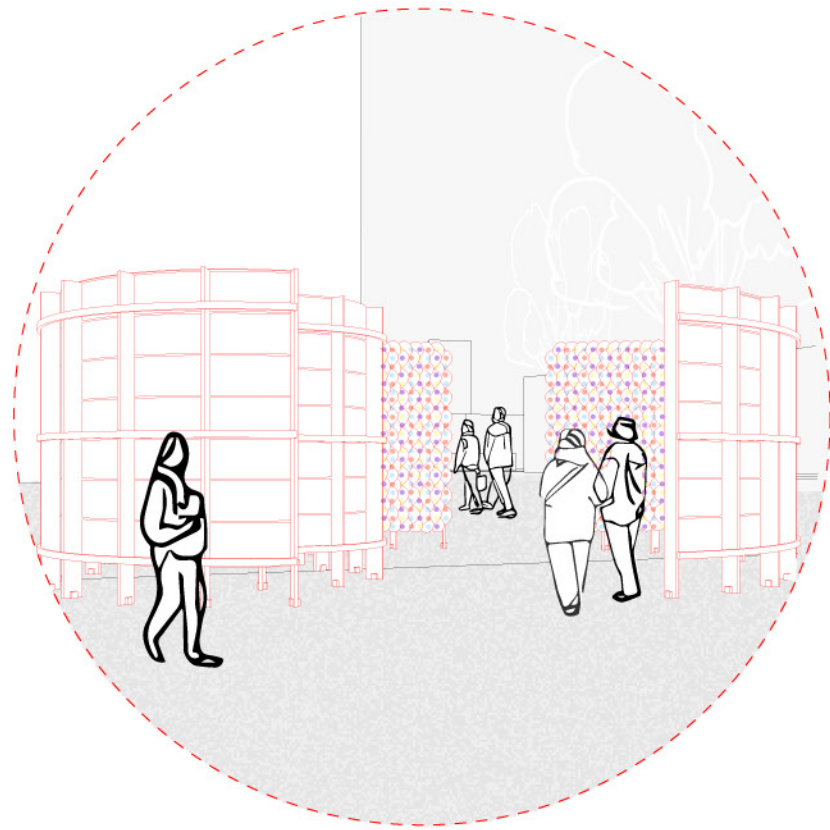

Freestanding Condition



Alley Condition

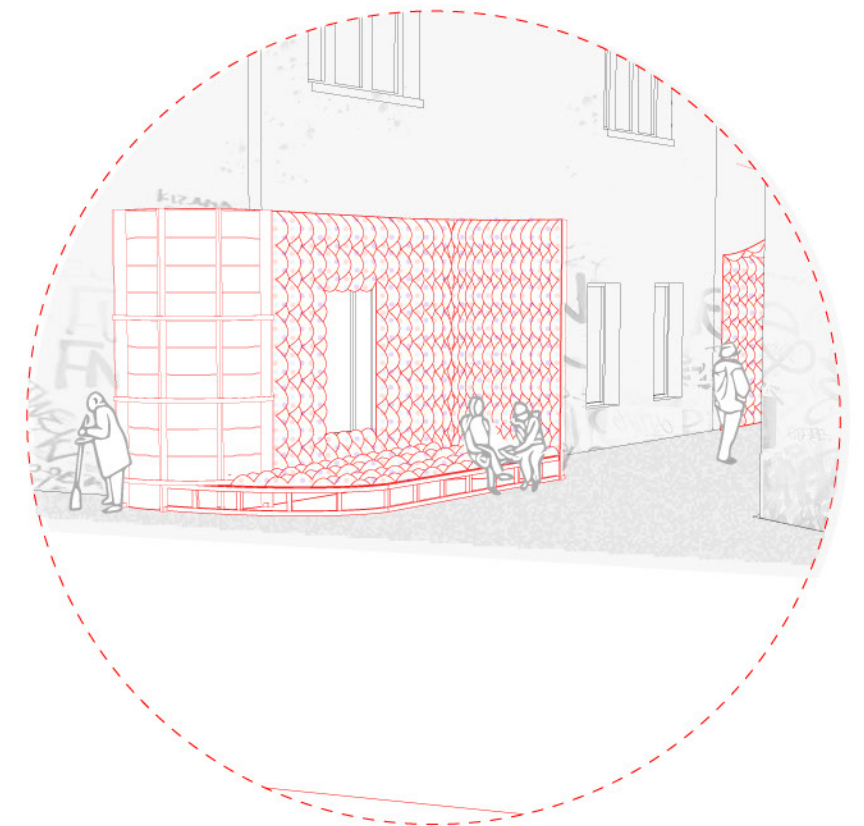
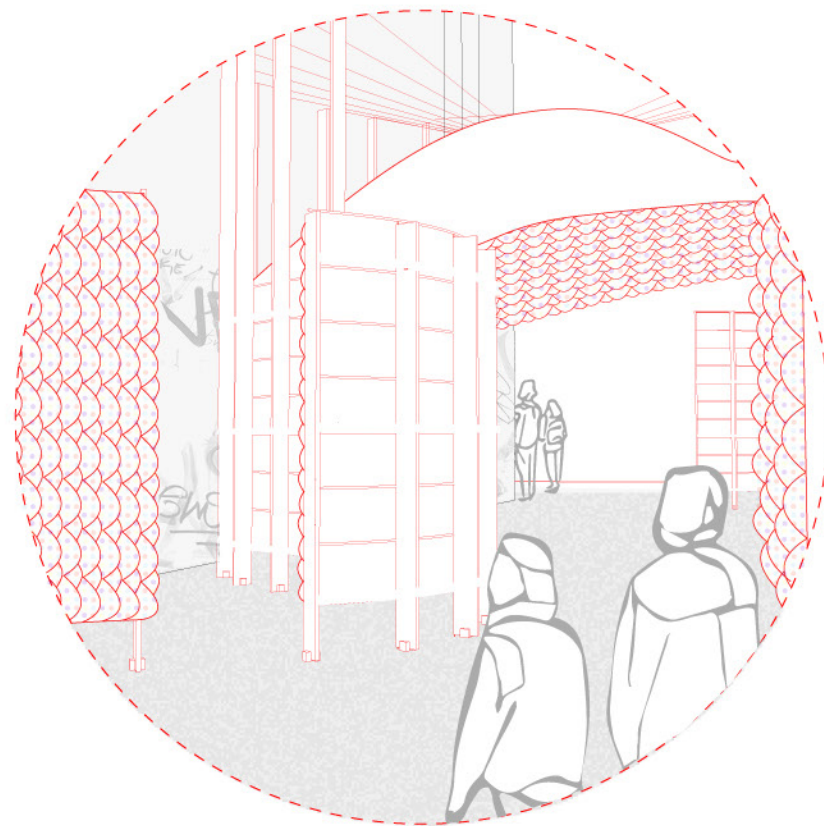
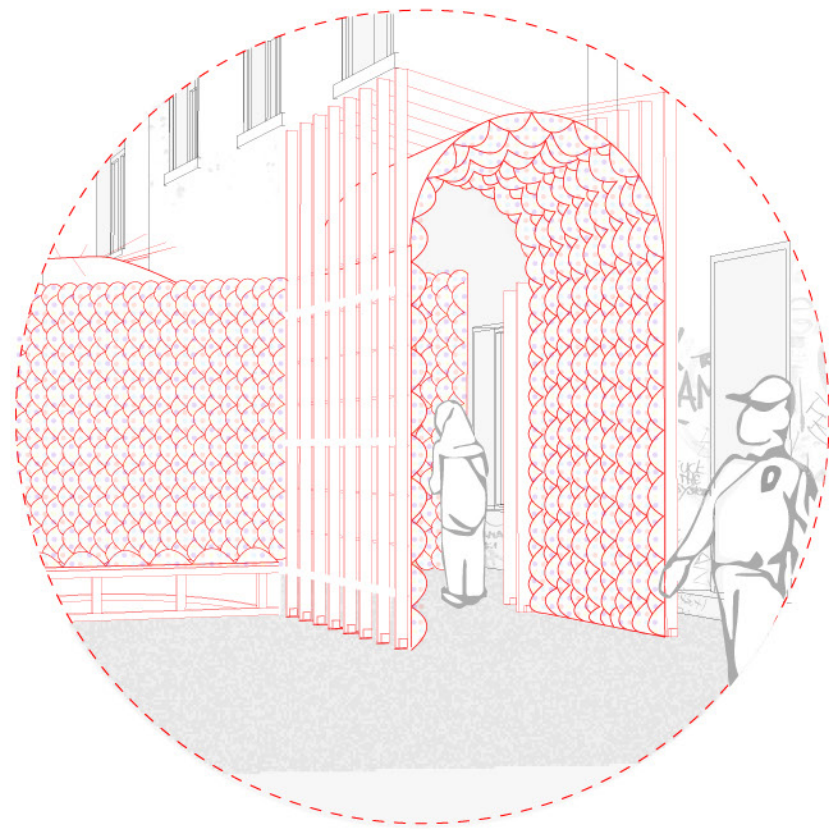

Alley Condition

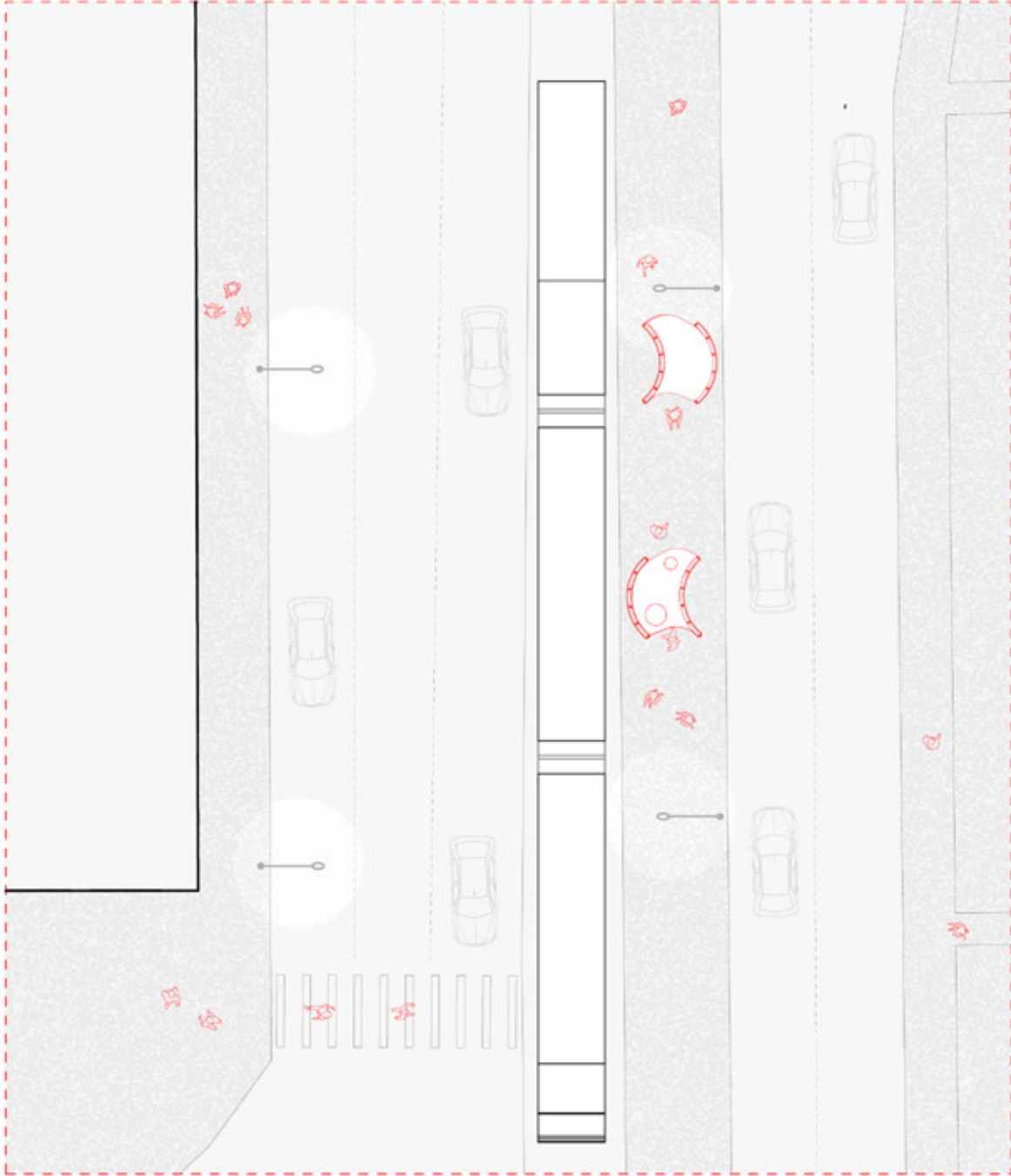
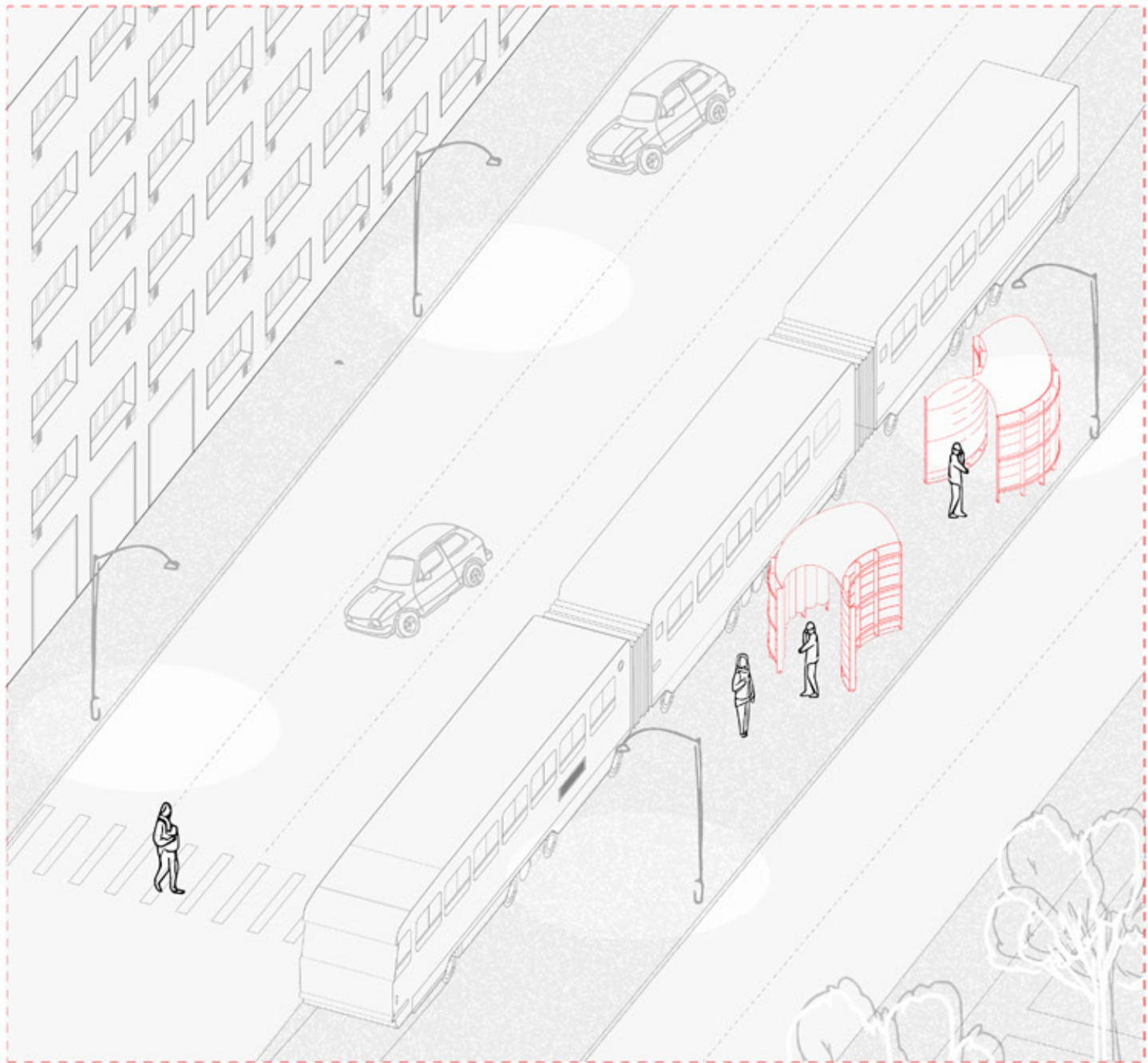

Bus Stop Condition

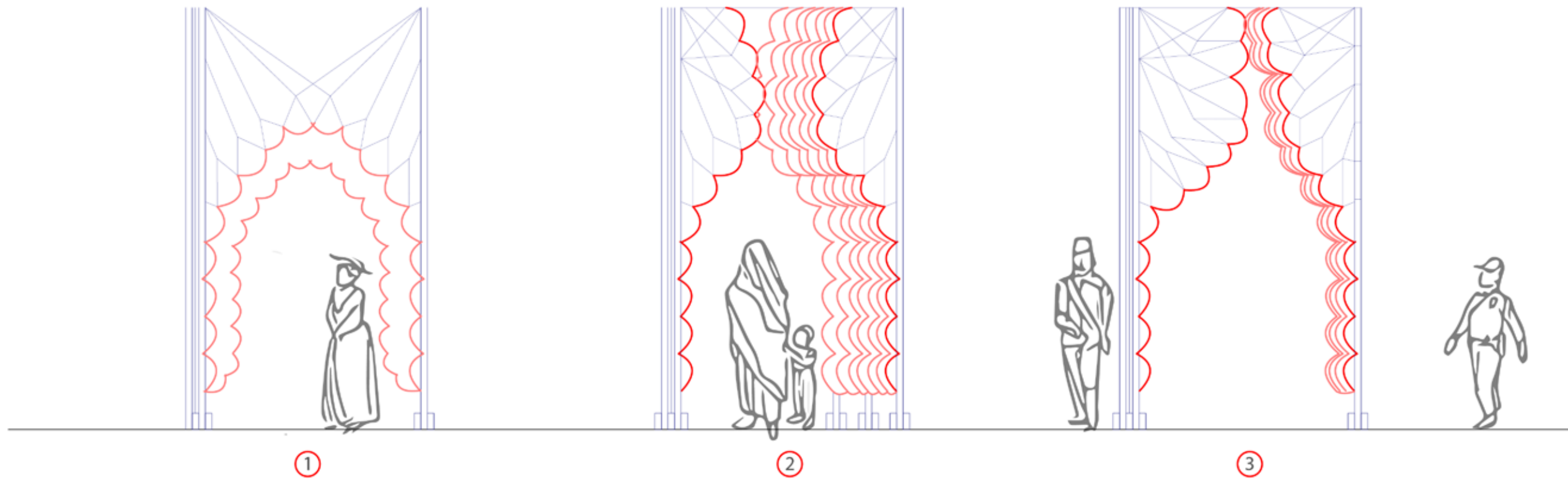

Bus Stop Condition Sections

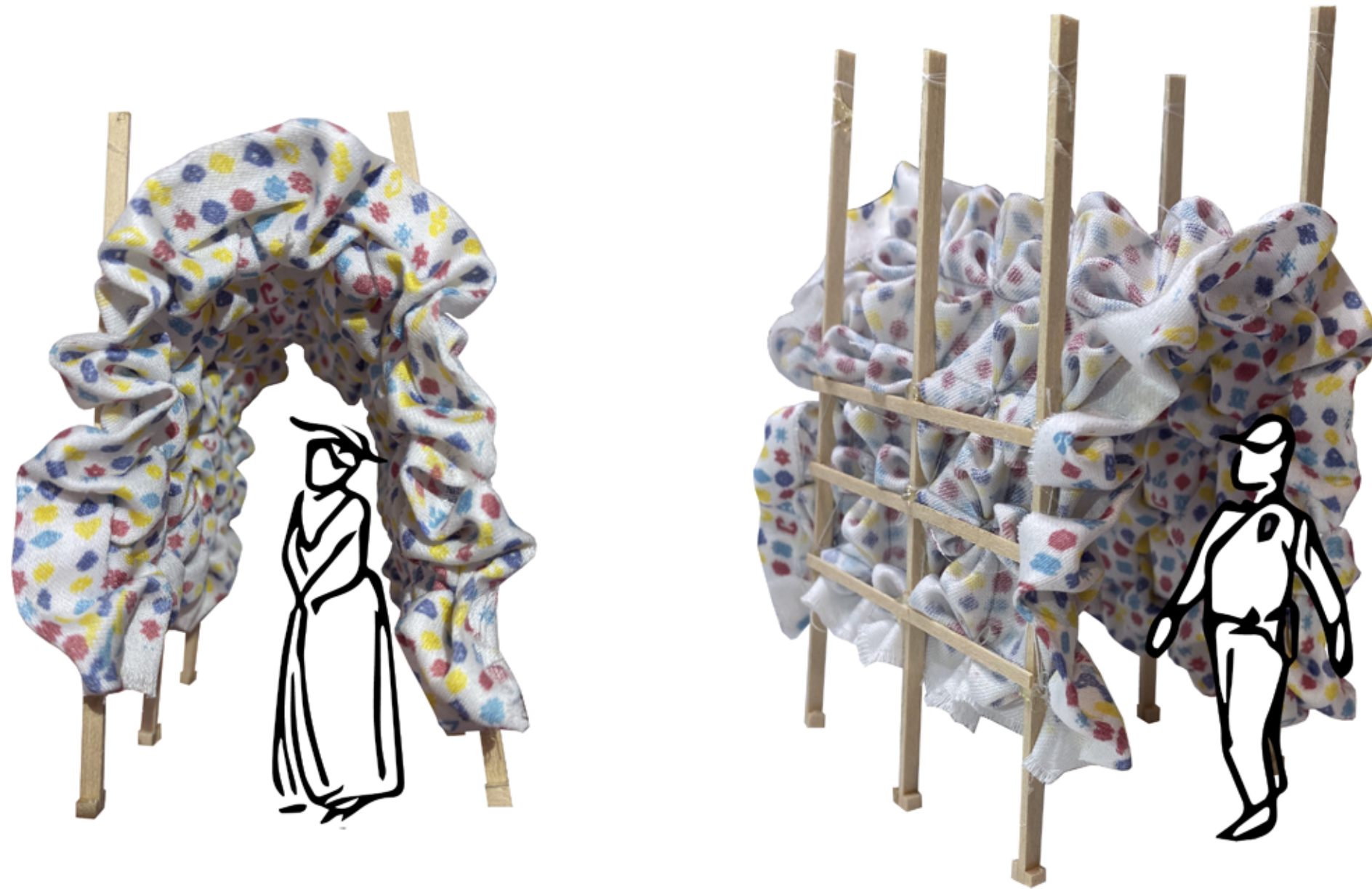

Bus Stop Condition



Bus Stop Condition





